

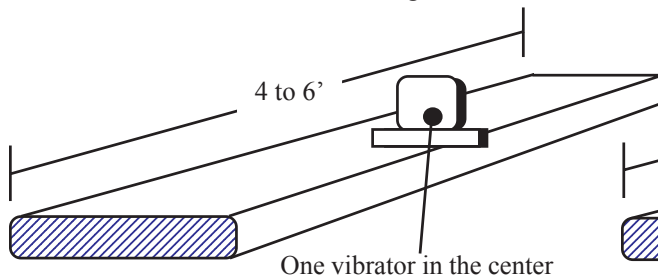

Denver Concrete Vibrator

## Build Your Own Self-Propelled Screed\*

On screeds that are 4 to 6' long, usually one vibrator in the center is enough



On screeds that are 6 to 12' long\*, two vibrators placed one-third the distance from the ends will produce very good results.

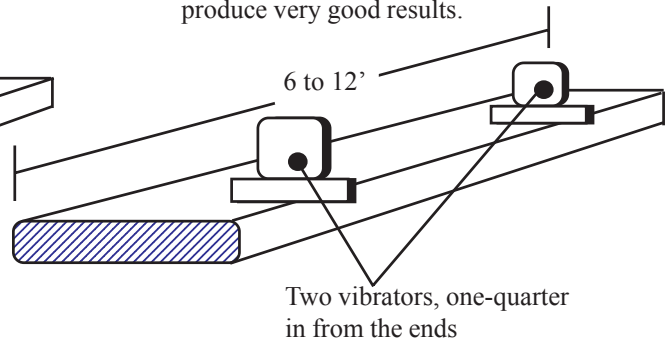

Position the center line of the vibrator approximately 2 to 4 inches in front of the center line of the screed.

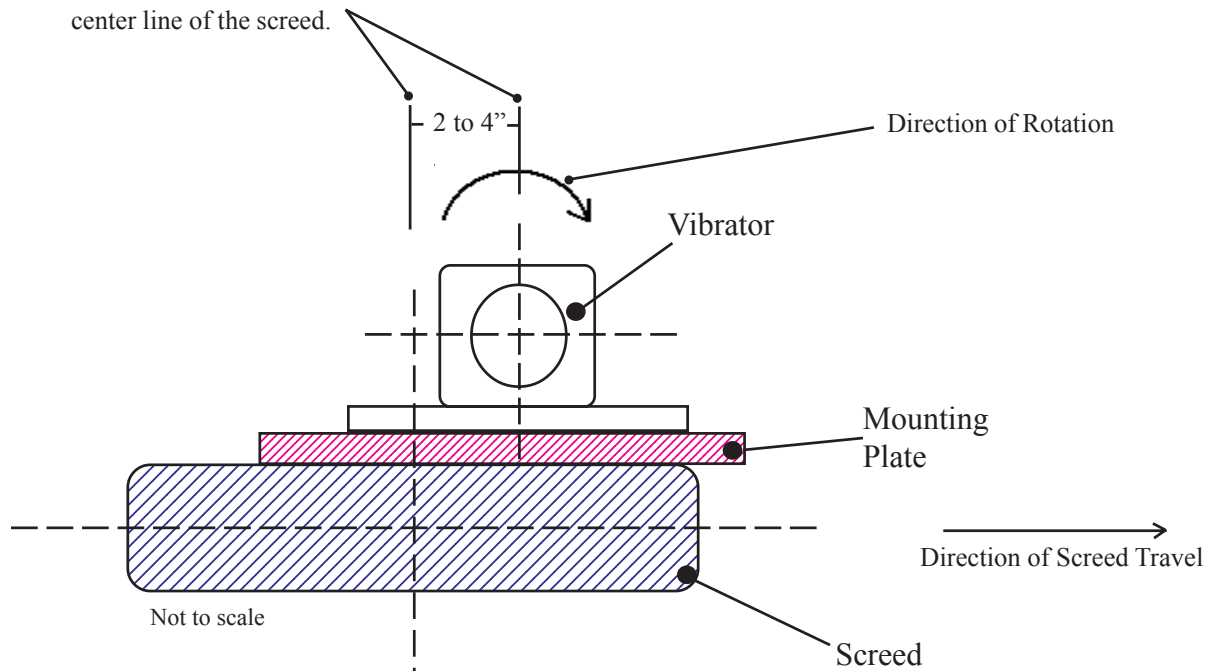

\* On screeds longer than 12' please contact the factory. For non-propelled screeds, center the vibrators.

℄

Area of Influence

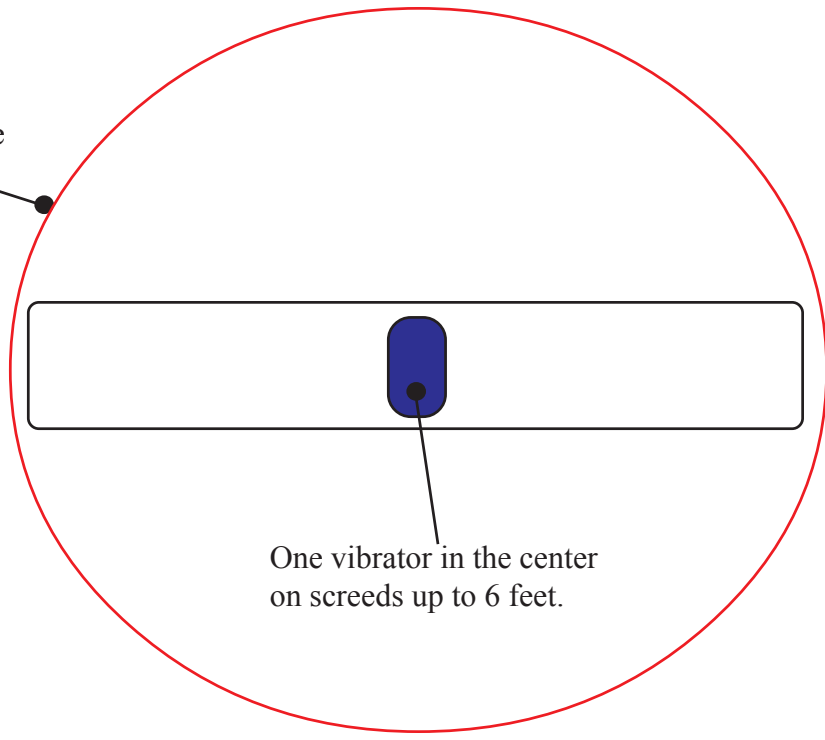

One vibrator in the center on screeds up to 6 feet.

Two vibrators on screeds from 6 to 12 feet.

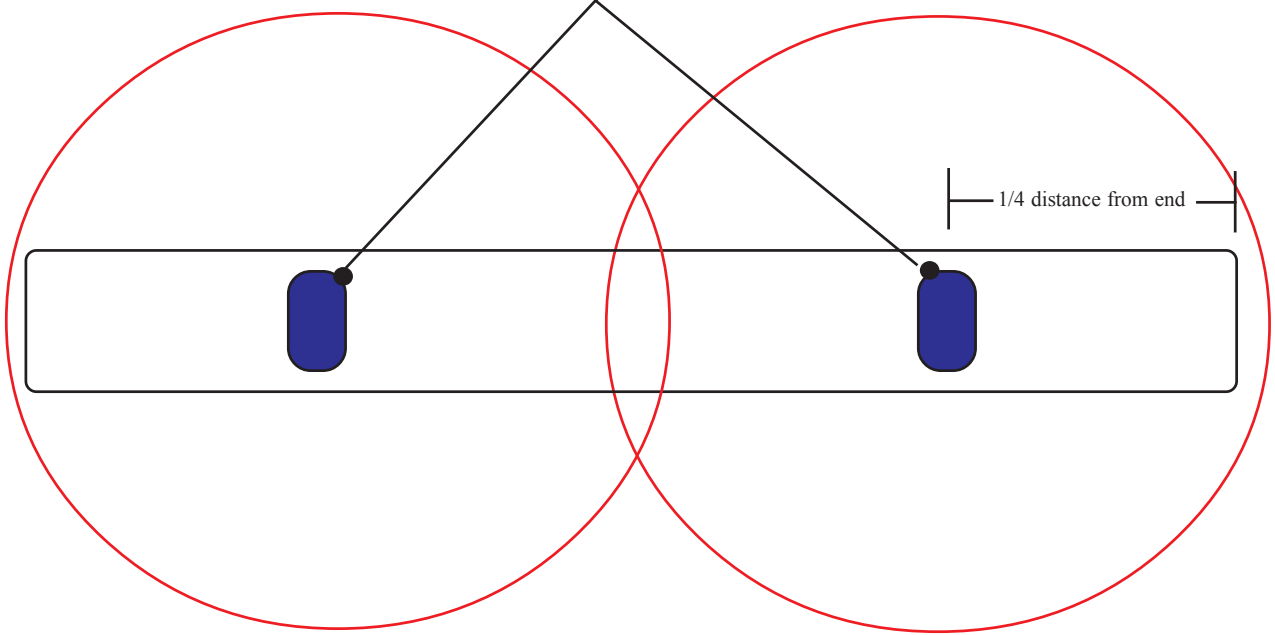

1/4 distance from end



Denver Concrete Vibrator

## Simple Screenshot Ideas

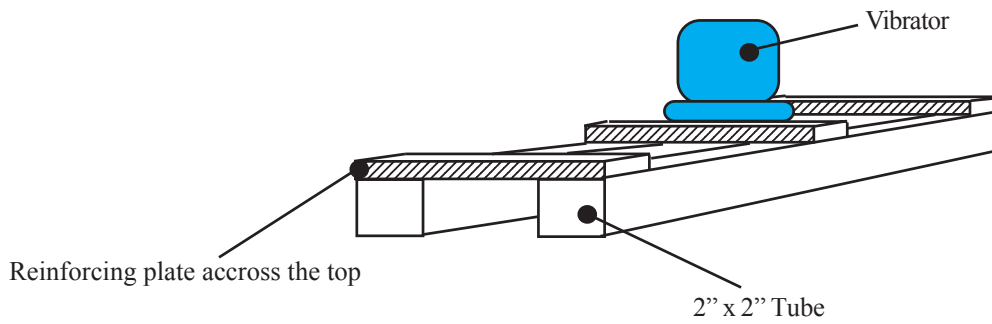
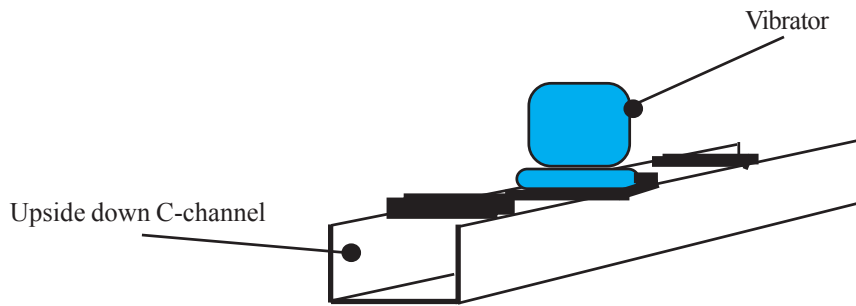

## Denver Vibrator

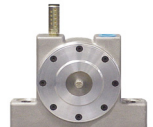
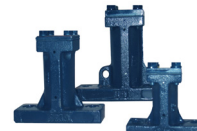

*"Your one stop source for vibration solutions"*